

ADM 322S: Rotary actuator with positioner

How energy efficiency is improved

Best operating convenience, precision activation and high energy efficiency with minimal operating noise.

Features

- For operating control units such as control valves, butterfly valves etc.
- For controllers with a continuous output
- 15 Nm nominal torque and holding torque
- ADM322SF122: Synchronous motor with electronic control unit and load-dependent cut-off
- ADM322SF152: Brushless DC motor with SUT (SAUTER Universal Technology) electronic control unit and electronic, load-dependent cut-off
- Low operating noise
- Automatic recognition of applied control signal
- With the built-in absolute distance measurement system, the position is always maintained in the case of power failure
- The direction of operation, running time and control signal (voltage/current) can be adjusted via coding switches
- High-speed variant ADM322SF152 with 30 s or 60 s for angle of rotation 90°
- Gear unit can be disengaged for manual adjustment
- Easy re-initialisation using a coding switch
- Electrical parallel operation of up to five actuators possible
- Numerous adapters enable the unit to be fitted onto defined non-SAUTER control valves
- ADM322SF152: Integrated forced operation can be set via coding switches (with selectable direction of operation)
- Maintenance-free gearbox made of plastic and steel, and gearbox base-plates made of steel
- Mounting columns made of aluminium

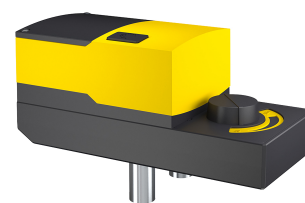

ADM322SF1*2



Technical data

Power supply

	Power supply 24 V~	± 20%, 50...60 Hz
	Power supply 24 V=	-10%...20%
	Connections (screw terminals)	Max. 1.5 mm ²
ADM322SF122	Power consumption	< 2.5 W
ADM322SF152	Power consumption	< 2.3 W

Parameters

	Operating noise ¹⁾	< 30 dB(A) (loaded)
	Response time	< 200 ms
	Angle of rotation	Maximum 95°
	Rotational torque and holding torque	15 Nm
ADM322SF122 positioner	Control signal y	0...10 V, R _i ≥ 50 kΩ, 0...20 mA, R _i ≤ 50 Ω 2...10 V (4...20 mA)
	Positional feedback signal y ₀	0...10 V; load ≥ 5 kΩ
	Starting point U ₀	0 or 10 V
	Starting point I ₀	0 or 20 mA
	Control span ΔU	10 V
	Switching range X _{sh}	130 mV, 0.26 mA
	Control span ΔI	20 mA
	Max. admissible line resistance	3 Ω
ADM322SF152 positioner	Control signal y	0...10 V, R _i ≥ 50 kΩ, 4...20 mA, R _i ≤ 50 Ω
	Positional feedback signal y ₀	0...10 V; load ≥ 5 kΩ
	Starting point U ₀	0 or 10 V
	Starting point I ₀	4 or 20 mA
	Control span ΔU	10 V

¹⁾ Operating noise with the slowest running time



Switching range X_{Sh}	130 mV, 0.26 mA
Control span ΔI	20 mA
Max. admissible line resistance	3 Ω

Ambient conditions

Operating temperature	-20...55 °C
Storage and transport temperature	-40...80 °C
Humidity without condensation	5...85 %rh

Construction

Dimensions W x H x D	194 x 166 x 86 mm
Weight	1.5 kg
Fitting position	Vertically upright to horizontal, not fitted upside down
Housing	Three-part
Housing material	Flame retardant yellow/black plastic
Cable inlet	With break-outs, for metric screw fittings M20x1.5

Standards and directives

	Type of protection	IP54 (EN 60529)
	Protection class	III (EN 60730-1), EN 60730-2-14
CE conformity according to	EMC Directive 2014/30/EU	EN 61000-6-1 EN 61000-6-2 EN 61000-6-3 EN 61000-6-4
	Low-Voltage Directive 2014/35/EU	EN 60730-1 EN 60730-2-14
	Over-voltage categories	III
	Degree of contamination	II
	Max. altitude	2000 m
	Machinery Directive 2006/42/EC (according to Appendix II, 1B)	EN ISO 12100

Overview of types

Type	Running time for 90°	Nominal voltage
ADM322SF122	120	24 V~/=
ADM322SF152	30 (60)	24 V~/=

Accessories

Type	Description
0510600001	Cable module, 1.2 m, 3-wire, PVC
0510600002	Cable module, 1.2 m, 3-wire, halogen-free
0510600003	Cable module, 1.2 m, 6-wire, PVC
0510600004	Cable module, 1.2 m, 6-wire, halogen-free
0510600005	Cable module, 5 m, 3-wire, PVC
0510600006	Cable module, 5 m, 3-wire, halogen-free
0510600007	Cable module, 5 m, 6-wire, PVC
0510600008	Cable module, 5 m, 6-wire, halogen-free
0313529001	Split-range unit for adjusting sequences, fitted in separate junction box
0510240013	ADM322 mounting kit with M3R, M4R, MH32, MH42
0510240014	ADM322 fitting kit with DEF DN20...65
0510240015	ADM322 fitting kit with DEF DN80...100
0510390002	Adapter set for control valve, Honeywell, DZ/ZR valves only
0510390003	Adapter set for control valve, Danfoss
0510390004	Adapter set for control valve, Caleffi
0510390005	Adapter set for control valve, Coster

ADM322SF152 only

Type	Description
0500420002	4...20 mA feedback module
0500570003	Constant 230 V module
0510220001	CASE Drives configuration tool

Intended use

This product is only suitable for the purpose intended by the manufacturer, as described in the "Operation of ADM32SF1*2" section.

All related product documents must also be adhered to. Modifying or converting the product is not admissible.

Operation of ADM322SF122

In the end positions (control valve limit stop or when the maximum angle of rotation is reached) or upon overload, the (mechanical) load-dependent cut-off responds before the electronic control unit turns off the motor.

The manual adjustment is performed by releasing the gear unit (button on top of housing) and simultaneously adjusting the spindle adapter. This enables the manual positional setting.

When the button is released, the gear unit is automatically coupled in and the target position assumed (without initialisation).

Connection to a control voltage (0...10 V or 0...20 mA)

The built-in positioner controls the actuator depending on controller's control signal Y.

A voltage signal (0...10 V=) at terminal O3 serves as the control signal.

Coding switch S2 can be used to switch a control signal 0...10 V= to 2...10 V=.

Coding switch S3 can be used to switch voltage signal 0...10 V to current signal 0...20 mA (or to 4...20 mA with coding switch S2).

If there is voltage on terminals MM/O1 and a rising control signal, the adapter rotates in the anti-clockwise direction. The direction of operation can be reversed with coding switch S1.

The starting point and control span are fixed. For setting partial ranges (only for voltage input), a split-range unit is available as an accessory (see split-range unit function).

After the connection of the power supply, the actuator moves to every angle of rotation between 0% and 100%, depending on the control signal. Due to the absolute distance measurement system, no angle of rotation is left out, and the actuator does not require periodic re-initialisation.

When the end positions are reached, the position is checked, corrected if necessary, and saved again.

If the control signal 0...10 V is interrupted in the direction of operation 1 (coding switch position OFF), the actuator moves to 0% angle of rotation.

If the control signal 0...10 V is interrupted in the direction of operation 2 (coding switch position ON), the actuator moves to 100% angle of rotation.

Re-initialisation and feedback signal

As delivered ex works, the actuator is already initialised to an angle of rotation of 90°.

If the angle of rotation of the control valve or butterfly valve is less than 90°, the actuator must be re-initialised after fitting. A re-initialisation is triggered by switching coding switch S4 from OFF to ON or vice versa. During initialisation, the feedback signal corresponds to the input signal. The re-initialisation is only valid when the whole process is complete.

If the angle of rotation is changed (e.g. by using a different control valve), a re-initialisation must be triggered so that the new angle of rotation can be adapted.

If the rotary actuator detects jamming during normal operation, it reports this by setting the feedback signal to 0 V after approx. 90 s. During this time, the actuator continues to try to overcome the jamming. If the jamming can be overcome, the normal control function is activated again and the feedback signal is restored.

Operation of ADM322SF152

Depending on the type of connection (see connection diagram), the actuator can be used as a continuous (0...10 V or 4...20 mA), 2-point (OPEN/CLOSE) or a 3-point actuator (OPEN/STOP/CLOSE).

The positioning time of the actuator can be set with coding switch S1 according to the respective requirements.

Using switch S2, the direction of operation can be changed.

In the end positions (limit stop or when the maximum angle of rotation is reached) or upon overload, the electronic motor cut-off (no limit switch) responds and turns off the motor.

The manual adjustment is performed by releasing the gear unit (button on top of housing) and simultaneously adjusting the spindle adapter. This enables the manual positional setting. When the button is released, the gear unit is automatically coupled in and the target position assumed (without initialisation).

Connection as 2-point valve actuator (24 V)

The OPEN/CLOSE activation is via two wires.

The actuator is connected to a permanent voltage via terminal MM and terminal O2.

When voltage (24 V) is applied to terminal O1, the actuator moves in the clockwise direction to the end position (0%). After the voltage is switched off at terminal O1, the actuator automatically retracts into the base position (100%).

Terminal O3 must not be connected or touch other contacts. We recommend that you insulate these.

Connection as 3-point valve actuator (24 V)

If voltage is applied to terminals MM and O1 (or O2), the control valve or butterfly valve can be moved to any position. If voltage is applied to terminals MM and O1, the actuator moves in the clockwise direction. If the electrical circuit is closed on terminal MM and O2, the actuator moves in the anti-clockwise direction. If there is no voltage on terminals O1 and O2, the actuator remains in the respective position until voltage is applied again. Terminal O3 must not be connected or touch other contacts. We recommend that you insulate these.

Connection to a control voltage (0...10 V= or 4...20 mA)

The built-in positioner controls the actuator depending on controller's output signal Y. A voltage signal (0...10 V=) at terminal O3 serves as the control signal. Coding switch S4 can be used to switch to a current input signal (4...20 mA). If there is voltage on terminals MM and O1 and a rising control signal, the actuator moves in the anti-clockwise direction. The direction of operation can be reversed with coding switch S2. The starting point and control span are fixed. For setting partial ranges (only for voltage input), a split-range unit is available as an accessory (see split-range unit function). After the connection of the power supply and the initialisation, the actuator moves to every angle of rotation between 0% and 100%, depending on the control signal. Due to the absolute distance measurement system, no angle of rotation is left out, and the actuator does not require periodic re-initialisation. If the control signal 0...10 V is interrupted in the direction of operation 1 (coding switch OFF), the actuator moves in the anti-clockwise direction to the end position. If the control signal 0...10 V is interrupted in the direction of operation 2 (coding switch position ON), the actuator moves in the clockwise direction to the end position. This is true if the forced operation is switched off. (Coding switch S5 OFF)

Initialisation and feedback signal

The actuator initialises itself automatically when it is connected as a continuous actuator (not in 2-/3-point mode without a feedback signal). When a voltage is applied to the actuator for the first time, the actuator first moves to the first and then to the second limit stop, or to the internal actuator stop. The two values are recorded and stored by the absolute distance measurement system. The control signal and the feedback are adapted to this effective angle of rotation. After initialisation, the actuator goes to every angle of rotation between 0% and 100%, depending on the control voltage. In case of a power failure or the removal of the power supply, no re-initialisation needs to be carried out. The values remain saved. If the initialisation is interrupted, the initialisation is started again when the voltage is re-applied. You trigger a re-initialisation by switching coding switch S8 from OFF to ON or vice versa. After this is triggered, the LED flashes green. During initialisation, the feedback signal corresponds to the input signal. The initialisation is carried out with the fastest positioning time. The re-initialisation is only valid when the whole process is complete. If an angle of rotation change is carried out, a re-initialisation must be triggered so that the new angle of rotation can be adapted. If the rotary actuator detects jamming during normal operation, the feedback signal is set to 0 V after approx. 90 s. During this time, the actuator continues to try to overcome the jamming. If the jamming can be overcome, the normal control function is activated again and the feedback signal is restored. With 2-point or 3-point control without a feedback signal, no initialisation is performed. Continuous control can also be implemented with a 230 V~ power supply with the external accessory 0500570003 "230 V~ module". You must ensure that the neutral wire of the controller is connected to the control voltage. The neutral wire of the power supply may only be used for the 230V module.

Coding switch

ADM322SSF152

de Schalterkodierung
fr Codage de commutation
en Switch coding
it Codifica di intervento
es Codificación de conmutación
sv Kodomkopplare
nl Schakelcodering







de Stellzeit
fr Temps de positionnement
en positioning time
it tempo di manovra
es tiempo de ajuste
sv ställtid
nl steltijd

de Wirksinn*
fr Sens d'action
en Direction of operation
it Direzione dell'azione
es Sentido de mando
sv Driftriktning
nl Werkingsrichting

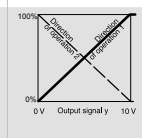
de Stellsignal
fr Signal de positionnement
en Positioning signal
it Segnale di regolazione
es Señal de mando
sv Styrsignal
nl Stuursignaal

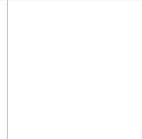
de Zwangssteuerung
fr Commande forcée
en Forced operation
it Comando forzato
es Mando desmodrómico
sv Tvångsstyrd ventil
nl Dwangbesturing

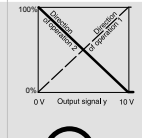
de Schliesspunkt Zwangssteuerung
fr Point de fermeture de la commande forcée
en Closing point for forced operation
it Comando forzato punto di bloccaggio
es Punto de cierre del mando desmodrómico
sv Stängningspunkt, tvångsstyrd ventil
nl Sluitpunt dwangbesturing

	<p>30 s</p>		<p>DC 0...10 V</p>	<p>prio. off</p>	
	<p>60 s</p>				
					

d Schalterkodierung
fr Codage de commutation
en Switch coding
it Codifica di intervento
es Codificación de conmutación
sv Kodomkopplare
nl Schakelcodering





de Stellzeit
fr Temps de positionnement
en positioning time
it tempo di manovra
es tiempo de ajuste
sv ställtid
nl steltijd

de Wirksinn*
fr Sens d'action
en Direction of operation
it Direzione dell'azione
es Sentido de mando
sv Driftriktning
nl Werkingsrichting

de Stellsignal
fr Signal de positionnement
en Positioning signal
it Segnale di regolazione
es Señal de mando
sv Styrsignal
nl Stuursignaal

de Zwangssteuerung
fr Commande forcée
en Forced operation
it Comando forzato
es Mando desmodrómico
sv Tvångsstyrd ventil
nl Dwangbesturing

de Schliesspunkt Zwangssteuerung
fr Point de fermeture de la commande forcée
en Closing point for forced operation
it Comando forzato punto di bloccaggio
es Punto de cierre del mando desmodrómico
sv Stängningspunkt, tvångsstyrd ventil
nl Sluitpunt dwangbesturing

			<p>4...20 mA</p>		
				<p>prio. on</p>	
					





ADM322SF122

de Schalterkodierung
 fr Codage de commutation
 en Switch coding
 it Codifica di intervento
 es Codificación de conmutación
 sv Kodomkopplare
 nl Schakelcodering

de Wirksinn
 fr Sens d'action
 en Direction of operation
 it Direzione dell'azione
 es Sentido de mando
 sv Driftriktning
 nl Werkingsrichting

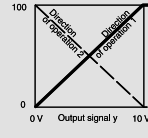
de Stellsignal
 fr Signal de positionnement
 en Positioning signal
 it Segnale di regolazione
 es Señal de mando
 sv Styrsignal
 nl Stuursignaal

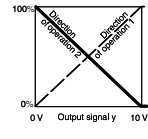
de Umstellung Spannungs-/Stromeingang
 fr Commutation entrée de tension/entrée de courant
 en Voltage/current input switch
 it Commutazione ingresso tensione /ingresso corrente
 es Conversión entrada de tensión/corriente
 sv Omkoppling, spännings-/strömångång
 nl Omstelling spannings-/stroomingang

		<p>DC 0...10 V 0...20 mA</p>	<p>U</p>
			
		<p>DC 2...10 V 4...20 mA</p>	
			<p>I</p>

LED

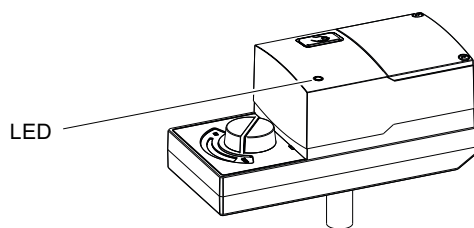

LED	Description
Flashes green	Initialisation
Lights up green	Spindle adapter turns left/right
Flashes red	Actuator jammed

Split-range unit, accessory 0313529001

Starting point U_0 and control span U can be set with the potentiometer. In this way, several control units can be operated in sequence or cascade by the control signal of the controller. The input signal (partial range) is amplified into an output signal of 0...10 V. This accessory cannot be built into the actuator but must be externally housed in an electrical junction box.

ADM322SF152 forced operation (in continuous mode)

Forced operation is activated via coding switch S5.

To use this function, an external 2-point controller must be attached to terminal 6.

The 2-point controller functions as a normally-closed contact. If the 2-point controller opens the electrical circuit, the actuator moves to the end position defined by coding switch S6.

Forced operation can be used only in continuous mode.

Engineering and fitting notes

The concept ensures electrical parallel operation of up to five rotary actuators of the same type.

The housing has two break-out cable inlets for metric screw fittings M20 × 1.5. When the screw fittings are being screwed in, these cable inlets are broken out automatically.

The cross-section of the power cable must be selected based on the cable length and the number of actuators. With five actuators wired in parallel and a cable length of 50 m, we recommend a cable cross-section of 1.5 mm² (power consumption of the actuator × 5). According to building installation regulations, the lines must be protected from overload or short circuit.

The rotary actuator is fitted on the control valve or the butterfly valve using the adapter (see accessory list).

The coding switches are accessible via an opening in the connection area of the actuator. Before the conversion, the equipment must be disconnected from the electricity supply.



WARNING!

Electric shock!

- ▶ Always ensure that the device is disconnected from the mains before removing the plastic cover for the connection area.

The actuators are not suitable for use in potentially explosive environments, on ships, in vehicles, in plants or in machinery where functional safety is required.

Specific standards such as IEC/EN 61508, IEC/EN 61511, EN ISO13849 and the like have not been taken into account.

Local requirements regarding installation, usage, access, access rights, accident prevention, safety, dismantling and disposal must be taken into account.



NOTICE!

Damage to property!

- ▶ Do not open the housing as otherwise the product will be damaged.

Outdoor installation

In case of installation outside buildings, the devices must also be protected from the weather!

Additional information

Document	
Fitting instructions	P100012579
Declaration on materials and the environment	MD 51.333

Disposal

When disposing of the product, observe the currently applicable local laws.

More information on materials can be found in the Declaration on materials and the environment for this product.

Power consumption at nominal voltage

Type	Running time for 90° (s)	Status	Active power P (W)	Apparent power S (VA)
ADM322SF122	120	Operation	< 2.5	5.0
		Standstill	< 0.3	
ADM322F152		Sizing	3.0	6.0
		Operation	< 2.3	4.5
		Standstill	< 0.5	
		Sizing	3.0	6.0

Dimension drawing

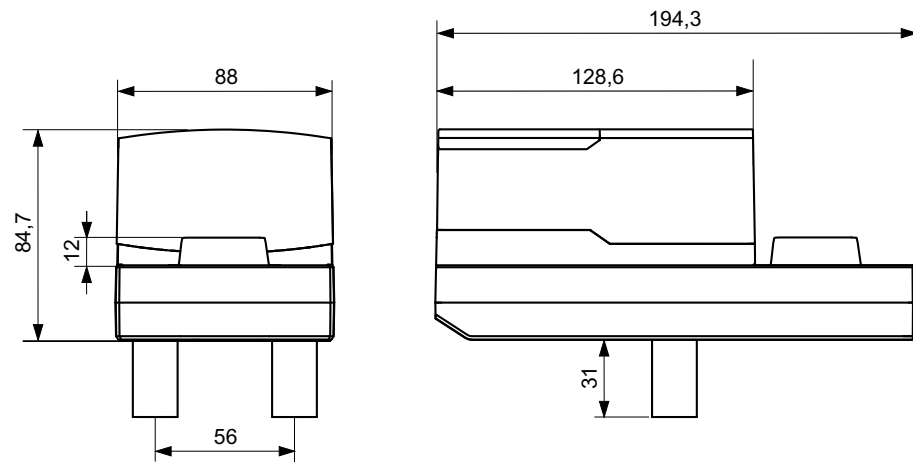

Connection diagram

**ADM322SF152
Modulating action**

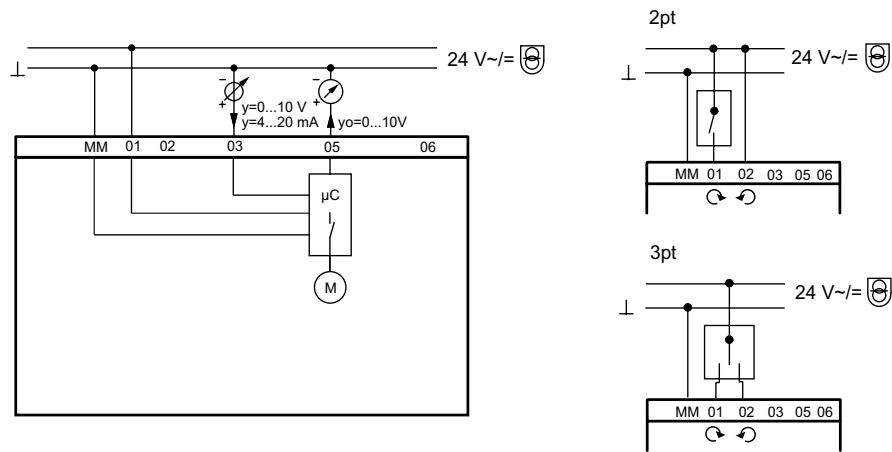

2pt/3pt Multi-position action with feedback signal

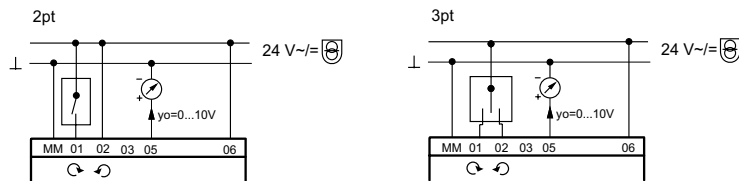

ADM322SF152

Modulating action with forced operation

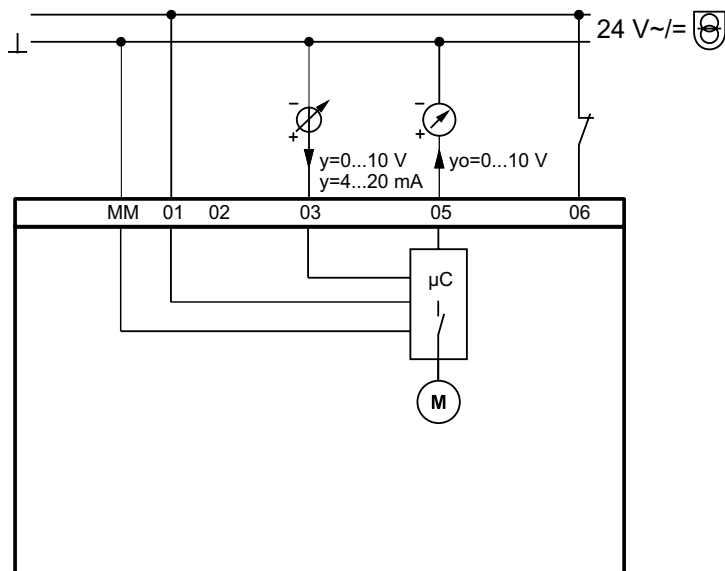

ADM322SF122

Modulating action

